



PDP90A

Position Sensing Detector

User Guide



















Table of Contents

Chapter 1	Warning Symbol Definitions	2
Chapter 2	Description.....	3
	2.1. Setup Instructions	3
	2.2. Details of Operation	3
	2.2.1. Overview.....	4
	2.2.2. Calculating the Position	4
	2.2.3. Position Resolution.....	5
Chapter 3	Specifications	7
Chapter 4	Regulatory.....	9
	4.1. Waste Treatment is Your Own Responsibility.....	9
	4.2. Ecological Background.....	9
Chapter 5	Thorlabs Worldwide Contacts.....	10

Chapter 1 Warning Symbol Definitions

Below is a list of warning symbols you may encounter in this manual or on your device.

Symbol	Description
	Direct Current
	Alternating Current
	Both Direct and Alternating Current
	Earth Ground Terminal
	Protective Conductor Terminal
	Frame or Chassis Terminal
	Equipotentiality
	On (Supply)
	Off (Supply)
	In Position of a Bi-Stable Push Control
	Out Position of a Bi-Stable Push Control
	Caution: Risk of Electric Shock
	Caution: Hot Surface
	Caution: Risk of Danger
	Warning: Laser Radiation
	Caution: Spinning Blades May Cause Harm

Chapter 2 Description

The PDP90A is a two-dimensional, tetra-lateral position sensing detector (PSD) that provides X and Y-axis positional information. It is designed to work with Thorlabs' TPA101 T-Cube Auto-Aligner. This sensor can be used for general alignment purposes, as well as precise position measurements. This sensor gives the position of any spot contained within the active region and supports spot sizes up to 9 mm in diameter. A spot between $\varnothing 0.2$ mm and $\varnothing 7$ mm is recommended.

Thorlabs also manufactures the PDQ80A quadrant position detector for precision alignment needs.

2.1. Setup Instructions

- a. Unpack and mount the PDP90A position-sensing detector. An AS4M8E M4 to 8-32 thread adapter is included for customers using metric opto-mechanics.
- b. Connect the sensor to a TPA101 T-Cube Auto-Aligner.
- c. Follow the directions in the controller's operating manual to ensure that the position-sensing detector is properly communicating with the controller.
- d. Send a beam onto the active area for measurement. The spot size input beam should be between $\varnothing 0.2$ and $\varnothing 7$ mm. For best results, the spot should be located within the center 80% of the surface of the detector (a 7.2 mm x 7.2 mm square). Adjust the power level so that the SUM output voltage is ≤ 4 V. This ensures the best signal-to-noise ratio and avoids signal saturation.

2.2. Details of Operation

This section of the manual discusses the operating principles of 2D lateral effect position sensing detectors and includes key equations for understanding their output signals.

2.2.1. Overview

2D lateral effect sensors accurately measure displacement - movements, distances, or angles – providing feedback from systems that require precise alignment, such as steering mirrors, microscope focusing, and fiber launch systems. These sensors are light-controlled variable resistors that work by proportionally distributing photocurrent to determine position in the X and Y from the four electrodes when incident light is applied to its surface.

In addition, the PDP90A is a continuous position-sensing detector, which derives position by dividing photo-generated electrons within their substrate, rather than by profiling the intensity distribution on the surface as with segmented detectors. There are two different types of lateral effect sensors available: duo-lateral and tetra-lateral.

Duo-lateral sensors provide a resistive layer on both the anode and cathode photodiode connections. This isolates the X and Y positional information of the sensor and allows the sensor to be highly linear and very accurate. However, the added resistive layers significantly increase manufacturing cost.

Tetra-lateral sensors use a single resistive layer with a common cathode and an anode on each side of the detection area. This makes them very inexpensive to manufacture, but their linearity decreases as the spot moves away from the center. This is caused by the physical location of the anodes along the sides of the sensor, specifically in the corners where the anodes approach each other.

Thorlabs PDP90A detector uses a variation of the tetra-lateral-type sensor commonly called a “pin cushion” position-sensing device. This sensor moves the anodes to the four corners of the sensors and reshapes the sensor area, to produce linearity comparable to a duo lateral sensor at a significantly lower cost.

The tetra-lateral-type, “pin cushion” has a characteristic form of which we will use some important values to determine further calculations. The active area is 9x9 mm at the waist of the pincushion; however, at the outer most regions the area goes to 10mm, therefore the calculations are performed from the widest part of the sensor.

2.2.2. Calculating the Position

The PDP90A includes circuitry to decode the D_x , D_y , and SUM signals as follows (see *Figure 1*):

$$\Delta x = (B + C) - (A + D)$$

$$\Delta y = (A + B) - (C + D)$$

$$SUM = (A + B + C + D)$$

Note: A, B, C and D are four electrodes on the upper surface, formed along each of the four edges

The following formulas will help you to determine the actual light beam position along the X and Y-axis.

$$x = \frac{L_x(\Delta x)}{2 \text{ SUM}} ; y = \frac{L_y(\Delta y)}{2 \text{ SUM}}$$

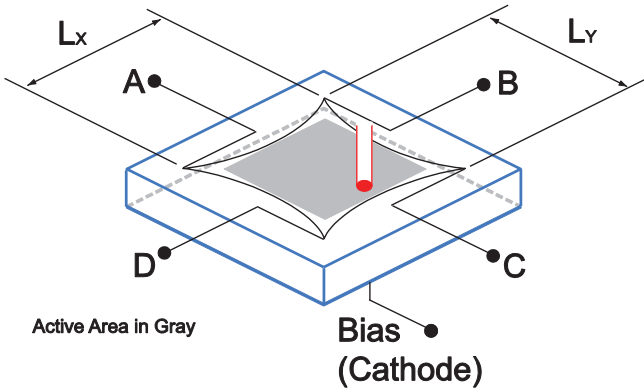

Figure 1 Layout of a Lateral Effect Position Sensor

2.2.3. Position Resolution

Position resolution is the minimum detectable displacement of a light spot incident on the PSD. Position resolution (ΔR) is a factor of both the resistance length (L_x or L_y), or the X and Y length, and the signal-to-noise ratio (S/N). The signal to noise ratio for this system can be defined as the SUM output signal level (V_0) divided by the output voltage noise (e_n). The PDP90A output noise is $<2 \text{ mV}_{pp}$, or $<300 \mu\text{V}_{rms}$:

$$\Delta R = L_x \left(\frac{e_n}{V_0} \right)$$

where ΔR is the resolution, L_x is the detector length (10 mm), e_n is the output noise voltage ($300 \mu\text{V}_{rms}$), and V_0 is the SUM output voltage level (4 V).

$$\Delta R = 10 \text{ mm} \left(\frac{300 \mu\text{V}_{rms}}{4 \text{ V}} \right) = 0.75 \mu\text{m}$$

For best results, V_0 should be maximized at 4 V, resulting in a position resolution of $0.75 \mu\text{m}$. To do this, monitor the SUM output voltage of the sensor and adjust the optical intensity until the output is approximately 4 V. Outputs above 4 V will saturate the system, causing unreliable readings. The software will indicate the voltage level on a slide bar, and is available for download online at thorlabs.com. To reach the download page go to Services, Downloads, Detectors, and then Position Sensing Detectors and click on the link. If the SUM is saturated, the slide bar color will turn red. Reduce the intensity until it switches to green. This will be equivalent to a 4 V SUM output.

Low power levels should be used for the position sensor. For the PDP90A, the max photocurrent is $40 \mu\text{A}$. Using the photosensitivity curve below (Figure 2), the system saturation power can be calculated as:

$$P_{max} = \frac{40 \mu\text{A}}{\text{Photosensitivity (in } \frac{\text{A}}{\text{W}})}$$

The TPA101 T-Cube PSD Auto Aligner has a sample resolution of 16-bits with an input voltage range of $\pm 15 \text{ V}$ (30 V range), or a voltage resolution of:

$$V_{step} = \frac{30 \text{ V}}{2^{16}} = 0.458 \text{ mV}$$

$$I_{step} = \frac{V_{step}}{\text{Transimpedance Gain}} = \frac{V_{step}}{100 \frac{\text{kV}}{\text{A}}} =$$

From this, the minimum power required can be determined based on the required accuracy. For example, if the user requires an accuracy of 1%, the minimum photocurrent is $I_{step} \times 100 = 0.458 \mu\text{A}$. Use the formula below to find the minimum optical power for a given wavelength.

$$P_{min} = \frac{0.458 \mu\text{A}}{\text{Photosensitivity (in } \frac{\text{A}}{\text{W}})}$$

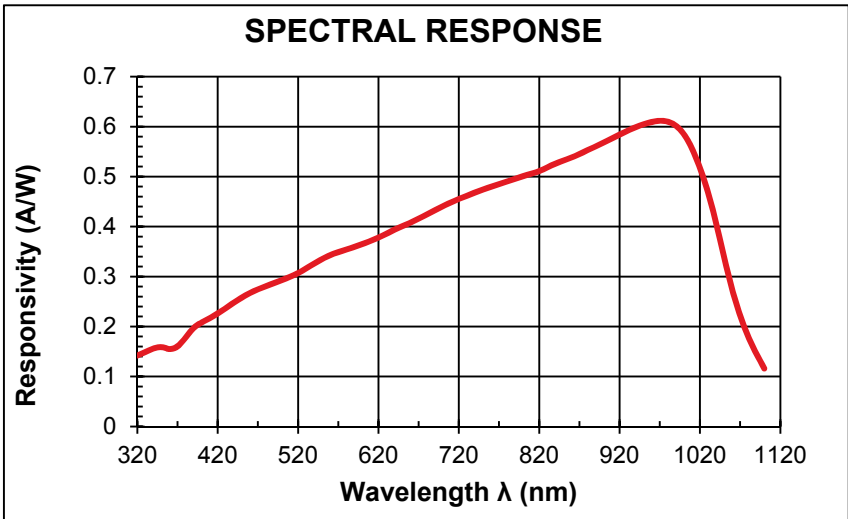

Figure 2 Photosensitivity of PDP90A

Chapter 3 Specifications

Electrical Specifications	
Wavelength Range	320 – 1100 nm
Peak Responsivity	0.6 A/W at 960 nm
Transimpedance Gain	100 kV/A
Photocurrent (Max)	40 μ A
Output Voltage Range: Pins 1,2 Pin 3	-4 to +4 V 0 to 4 V
Signal Output Offset	0.3 mV (Typical) 7 mV (Max)
Bandwidth	15 kHz
Spot Size ¹	\varnothing 0.2 to \varnothing 7 mm (Recommended) \varnothing 9 mm (Max)
Power Requirements	\pm 5 VDC \pm 5%, 35 mA

Physical Specifications	
Sensor Size	9 mm x 9 mm (0.35" x 0.35")
Mechanical Aperture	\varnothing 0.50" (\varnothing 12.7 mm)
Aperture Thread	Internal SM05 (0.535"- 40)
Dimensions	2.00" x 1.20" x 0.65" (50.8 mm x 30.5 mm x 16.5 mm)
Mounting Thread	8-32, 0.25" Thread Depth (Min)
Included Metric Adapter	External 8-32 to Internal M4 (Thorlabs Item # AS4M8E)
Cable Length	5' (1.5 m) (Typ.)
Connector Plug	Hirose HR10A-7P-6P
Mating Receptacle	Hirose HR10A-7R-6S
Weight	0.25 lbs. (114 g)
Sensor Depth	7.07 mm (0.28")
Operating Temperature	10 to 40 °C
Storage Temperature	-20 to 80 °C

¹ \varnothing 9 mm (Max) at the waist of the pincushion.

Chapter 4 Drawing

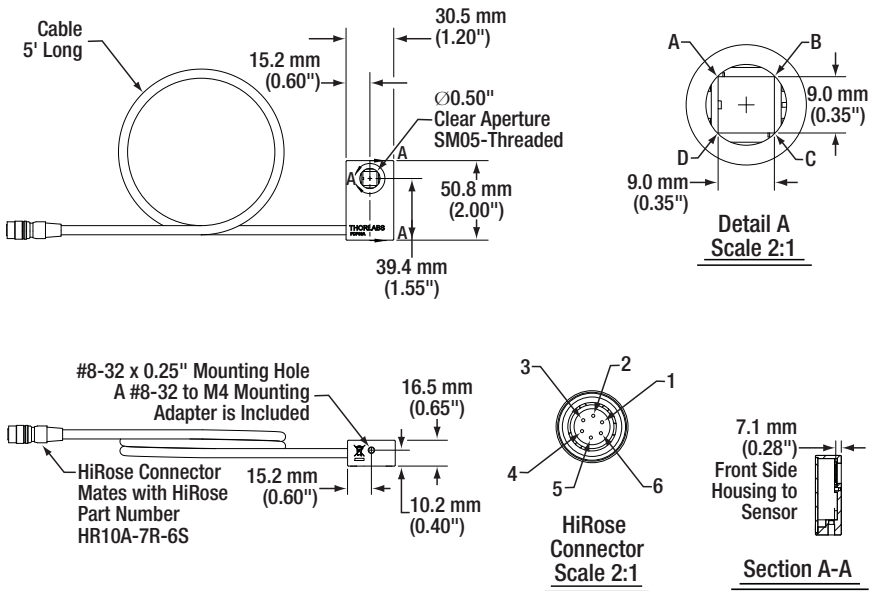

Pin	Description
1	X-Axis $[B + C] - [A + D]$
2	Y-Axis $[A + B] - [C + D]$
3	SUM $[A + B + C + D]$
4	+Vsupply (+5 V)
5	Common
6	-Vsupply (-5 V)

Chapter 5 Regulatory

As required by the WEEE (Waste Electrical and Electronic Equipment Directive) of the European Community and the corresponding national laws, Thorlabs offers all end users in the EC the possibility to return “end of life” units without incurring disposal charges.

- This offer is valid for Thorlabs electrical and electronic equipment:
- Sold after August 13, 2005
- Marked correspondingly with the crossed out “wheelie bin” logo (see right)
- Sold to a company or institute within the EC
- Currently owned by a company or institute within the EC
- Still complete, not disassembled and not contaminated

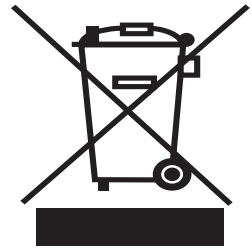

Wheelie Bin Logo

As the WEEE directive applies to self-contained operational electrical and electronic products, this end of life take back service does not refer to other Thorlabs products, such as:

- Pure OEM products, that means assemblies to be built into a unit by the user (e.g. OEM laser driver cards)
- Components
- Mechanics and optics
- Left over parts of units disassembled by the user (PCB's, housings etc.).

If you wish to return a Thorlabs unit for waste recovery, please contact Thorlabs or your nearest dealer for further information.

5.1. Waste Treatment is Your Own Responsibility

If you do not return an “end of life” unit to Thorlabs, you must hand it to a company specialized in waste recovery. Do not dispose of the unit in a litter bin or at a public waste disposal site.

5.2. Ecological Background

It is well known that WEEE pollutes the environment by releasing toxic products during decomposition. The aim of the European RoHS directive is to reduce the content of toxic substances in electronic products in the future.

The intent of the WEEE directive is to enforce the recycling of WEEE. A controlled recycling of end of life products will thereby avoid negative impacts on the environment.

Chapter 6 Thorlabs Worldwide Contacts

USA, Canada, and South America

Thorlabs, Inc.
56 Sparta Avenue
Newton, NJ 07860
USA
Tel: 973-300-3000
Fax: 973-300-3600
www.thorlabs.com
www.thorlabs.us (West Coast)
Email: sales@thorlabs.com
Support: techsupport@thorlabs.com

Europe

Thorlabs GmbH
Hans-Böckler-Str. 6
85221 Dachau
Germany
Tel: +49-(0)8131-5956-0
Fax: +49-(0)8131-5956-99
www.thorlabs.de
Email: europe@thorlabs.com

France

Thorlabs SAS
109, rue des Côtes
78600 Maisons-Laffitte
France
Tel: +33 (0) 970 444 844
Fax: +33 (0) 825 744 800
www.thorlabs.com
Email: sales.fr@thorlabs.com

Japan

Thorlabs Japan, Inc.
Higashi-Ikebukuro Q Building 2F
2-23-2, Higashi-Ikebukuro,
Toshima-ku, Tokyo 170-0013
Japan
Tel: +81-3-5979-8889
Fax: +81-3-5979-7285
www.thorlabs.jp
Email: sales@thorlabs.jp

UK and Ireland

Thorlabs Ltd.
1 Saint Thomas Place, Ely
Cambridgeshire CB7 4EX
Great Britain
Tel: +44 (0)1353-654440
Fax: +44 (0)1353-654444
www.thorlabs.com
Email: sales.uk@thorlabs.com
Support: techsupport.uk@thorlabs.com

Scandinavia

Thorlabs Sweden AB
Bergfotsgatan 7
431 35 Mölndal
Sweden
Tel: +46-31-733-30-00
Fax: +46-31-703-40-45
www.thorlabs.com
Email: scandinavia@thorlabs.com

Brazil

Thorlabs Vendas de Fotônicos Ltda.
Rua Riachuelo, 171
São Carlos, SP 13560-110
Brazil
Tel: +55-16-3413 7062
Fax: +55-16-3413 7064
www.thorlabs.com
Email: brasil@thorlabs.com

China

Thorlabs China
Room A101, No. 100
Lane 2891, South Qilianshan Road
Putuo District
Shanghai
China
Tel: +86 (0) 21-60561122
Fax: +86 (0)21-32513480
www.thorlabchina.cn
Email: chinasales@thorlabs.com



THORLABS
www.thorlabs.com
